

STANDARD EQUIPMENT

ISO standard cabin ·Cabin ROPS(ISO 3471) FOPS(ISO 3449) TOPS(ISO 12117)	·Lockable door ·Accessory box ·Centralized monitoring ·Gauges Fuel level gauge Engine coolant temperature gauge ·Warning Quick clamp	Engine oil pressure Engine coolant temperature Preheat Low battery Air cleaner clogging Fuel empty ·Door and locks, one key ·Mechanical suspension seat with seat belt	·Radio / USB Player ·Console box tilting system(LH.) ·Two front working lights ·Electric horn ·Battery (1 x 12 V x 80 AH) ·Battery master switch ·Automatic swing brake ·Removable reservoir tank ·Water separator, fuel line	·Mono boom (2.5 m, 8' 2") ·Arm (1.3 m, 4' 3") ·Rubber shoe (300mm, 12") ·Single acting piping (Breaker, etc) ·Double acting piping (Clamshell, etc)
--	---	---	---	---

OPTIONAL EQUIPMENT

ISO standard canopy ·Canopy ROPS(ISO 3471) FOPS(ISO 3449) TOPS(ISO 12117)	·Beacon lamp ·Accumulator, work equipment lowering ·Travel alarm	·Quick coupler ·Tool kit ·Heater & Defroster ·Lever pattern change valve	·Steel shoe (300mm, 12") ·Air conditioner ·Long Arm (1.6m) ·Additional CWT (150kg, 330lb)
--	--	---	--

* Standard and optional equipment may vary. Contact your Hyundai dealer for more information. The machine may vary according to International standards.
* The photos may include attachments and optional equipment that are not available in your area.
* Materials and specifications are subject to change without advance notice.
* All imperial measurements rounded off to the nearest pound or inch.

PLEASE CONTACT

www.hyundai-ce.com

2014.05 Rev. 3

 **HYUNDAI**
HEAVY INDUSTRIES CO.,LTD.
CONSTRUCTION EQUIPMENT

Head Office
1000 BANGEOJINSUNHWAN-DORO, DONG-GU, ULSAN, 682-792, KOREA
TEL:(82)52-202-7722, 9807 FAX:(82)52-202-7720



We build a better future

Robex

35z-9

With Tier 4 Engine installed



*Photo may include optional equipment.

 **HYUNDAI**
HEAVY INDUSTRIES CO.,LTD.

Pride at Work

Hyundai Heavy Industries strives to build state-of-the-art earthmoving equipment to give every operator maximum performance, more precision, versatile machine preferences, and proven quality. Take pride in your work with Hyundai!

Robex 35Z-9

Machine Walk-Around

Rugged Upper and Lower Frame

The upper frame is designed to be heavy duty to absorb high stress load on the job. X-leg center frame and reinforced box section track frame provide exceptional strength and longer service life to withstand tough working conditions.

Engine Technology

The R35Z-9 is powered by a proven and reliable, Tier 4 certified YANMAR 3TNV88. This engine provides efficient fuel combustion and reduced noise.

Efficient Control System

Control devices are all conveniently located for improved operator comfort and productivity. A safety lever on the left-side console is designed to prevent exiting the cabin while hydraulic controls are live.

Advanced Hydraulic System

The R35Z-9 hydraulic system is precision designed for fast operation with fine control capabilities.

Comfortable and Durable Cabin

The cabin is roomy and ergonomically designed, with reduced sound levels and good visibility. Both canopy and cabin style frames meet international standards TOPS, ROPS, FOPS ensuring operator's safety.

Operator Convenience

The R35Z-9 features a suspension seat, foldable pedals for added space and multiple storage compartments. The monitoring system includes seven warning indicators, water temperature gauge, fuel gauge and hour meter for productive, convenient operating.

Easy and Simple Maintenance

An adjustable suspension seat, wrist rests, ergonomically designed joysticks and plenty of leg room help to reduce operator fatigue. A array of indicators and gauges are displayed on the monitor which keep the operator aware of machine performance at all times. The monitoring system includes seven warning indicators, water temperature gauge, fuel gauge and hour meter.

Extended Life of Components

The R35Z-9 reduces operating costs over time with long life hydraulic filters, hydraulic oil, shims and bushings.



*Photo may include optional equipment.

Preference

The R35Z-9 offers an operator an optimal work environment with a cabin designed for comfort and sophistication. Operating R35Z-9 is unique to every operator. Operators can fully customize their work environment and operating preferences to fit their individual needs.



*Photo may include optional equipment.



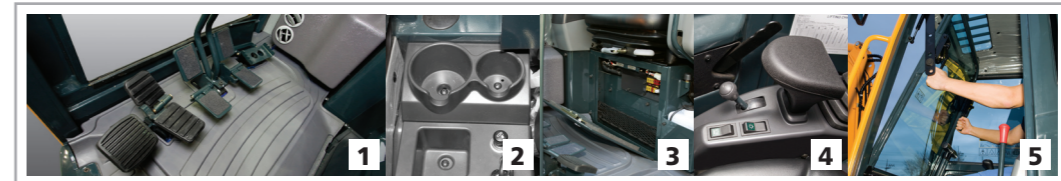
Monitor

The monitoring system of the R35Z-9 provides the operator with machine status information, including: engine oil pressure, battery charge, engine coolant temperature and a fuel gauge.

Comfortable Operating Cabin

In a 9 series cabin, you can easily adjust the seat and wrist rests settings to best suit your preferred operating condition.

1. All pedals are foldable for additional floor space. Foot rest, attachment pedal, left and right travel pedals and boom swing pedal are arranged for convenient access.
2. Two cup holders are integrated into the right console for large and small drink storage.
3. An additional storage box with key lock is accessible under the operator's seat.
4. Adjustable wrist rests provide additional comfort.
5. A sliding fold-in front window is easily opened and safely stored in an open position to improve ventilation and visibility.(Cabin type only)



Reduced Stress

An operator's work environment should be stress free. Hyundai's R35Z-9 compact excavator is designed for comfort, reduced sound and plenty of space to reduce stress on the operator.

Operator Comfort

The left and right control levers are ergonomically located for convenient access. A safety lock system is designed to prevent exiting the cabin while hydraulic controls are live. When the safety lever and left side console are positioned upright, hydraulic functions are disengaged.



A tiltable left-side console make the operator easier to enter and exit the cab.

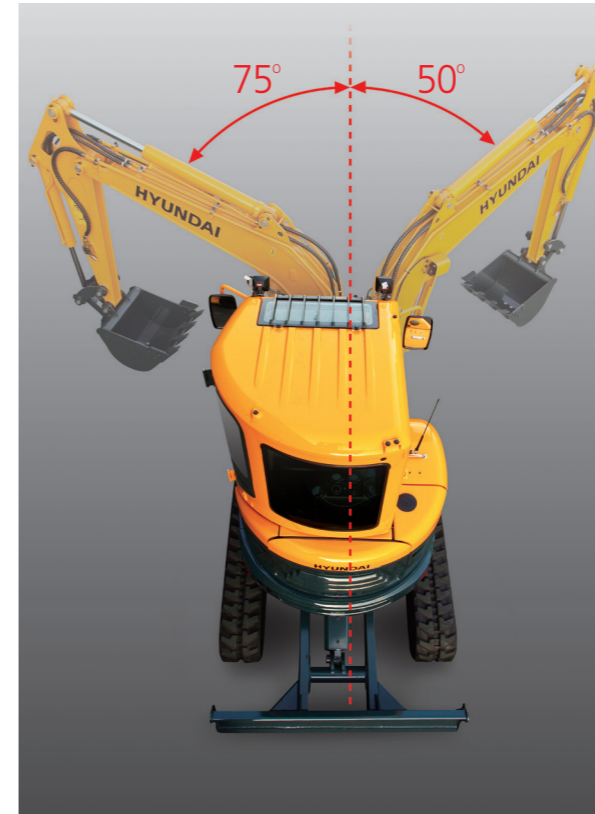


Performance & Precision

New technologies designed to improve performance and precision, make the R35Z-9 smooth, fast and easy to control.



*Photo may include optional equipment.



Boom Swing

The R35Z-9's boom swing function is designed for efficient work in congested residential and urban areas. The boom can be offset left or right within an operating range.

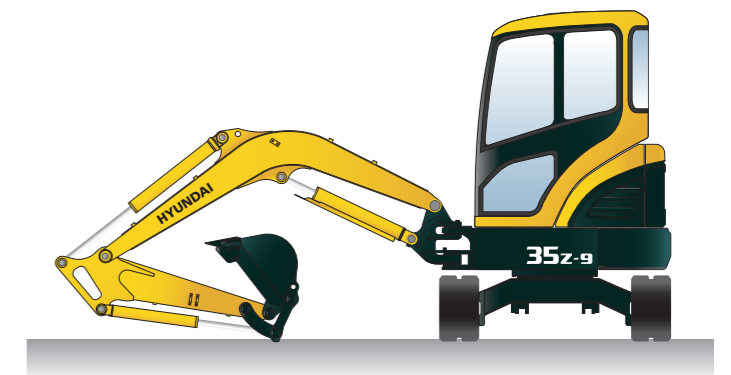
Improved Hydraulic System

Optimized matching between the joystick and main control valve improves fine control and smoothness of operation. An arm flow summation system provides energy savings, reduced cavitation and increased speed. To improve safety and avoid boom drift the R35Z-9 is equipped with an integrated boom holding system.



Structure Strength

The R35Z-9 cabin structure has been fitted with stronger but slimmer tubing for added safety and improved visibility. Low-stress, high strength steel is integrally welded to form a stronger, more durable upper and lower frame. Structural integrity was tested by way of FEM (Finite Elements Method) analysis and long-term durability tests.



Zero-tail Swing

R35Z-9's short tail swing radius allows the operator work in confined areas like close to buildings on roadways, and in urban areas. This compact radius design provides easy and efficient operation in any limited space work environment.

Yanmar 3TNV88

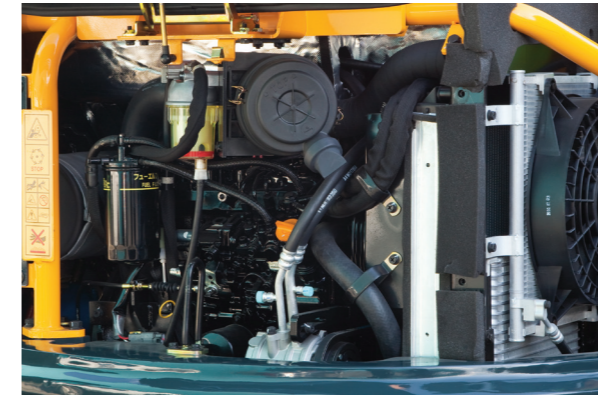
Tier 4 certified, Yanmar 3TNV88 engine provides maximum power, reliability, optimum fuel economy, and reduced emissions.

Profitability

R35Z-9 is designed to maximize profitability through improved efficiencies, enhanced service features and longer life components.

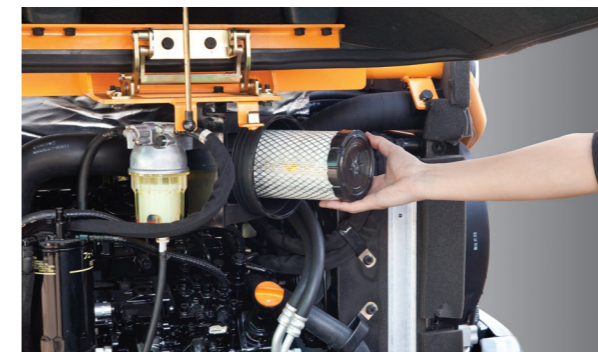


*Photo may include optional equipment.



Easy Access

The R35Z-9 was built with accessibility in mind. All doors, covers and hoods were built for complete open access. Regular service and maintenance is easy and convenient with the R35Z-9.



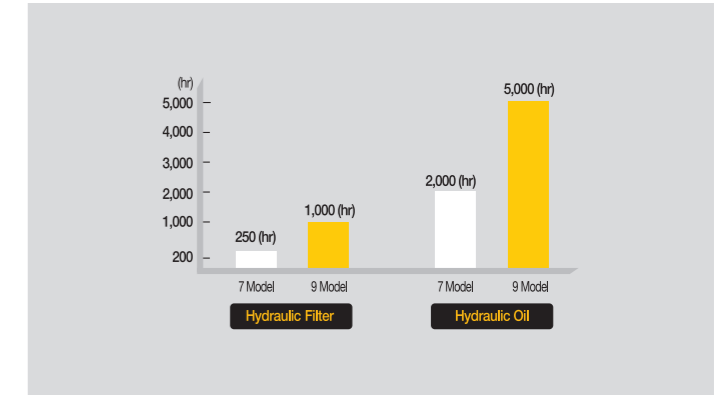
Easy Change Air Cleaner

The R35Z-9 is equipped with a durable plastic air cleaner designed for easy maintenance.



Lever Pattern Change Valve^(option)

Joystick control patterns can be changed through an optional pattern change valve positioned for easy access.



Extended the Life of Components

9 series excavators were designed with bushings designed for extended lube intervals (250 hrs) & polymer shims (wear resistant, noise reducing), extended-life hydraulic filters (1,000hrs), long-life hydraulic oil (5,000hrs), more efficient cooling systems and integrated preheating systems which extend service intervals, minimize operating costs and reduce machine down time.

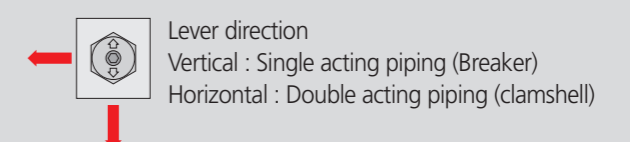


Centralized Grease Fittings

A centralized lubrication bank is available for faster, easier service and maintenance.



Selector Valve for Single or Double Acting Piping



Specifications

ENGINE

Model	Yanmar 3TNV88	
Type	Water cooled, 4 cycle Diesel, 3-cylinders in line, direct injection, low noise	
Rated flywheel horse power		
SAE	J1995 (gross)	27.3 HP (20.4kW) at 2,200rpm
	J1349 (net)	26.5 HP (19.8kW) at 2,200rpm
DIN	627 1/1 (gross)	27.6 PS (20.3kW) at 2,200rpm
	627 1/1 (net)	26.9 PS (19.8kW) at 2,200rpm
Max. torque	10.9 kgf·m(79 lbf·ft) at 1,100 rpm	
Bore x stroke	88mm x 90mm (3.5" x 3.5")	
Piston displacement	1,642cc (100 in ³)	
Batteries	12V - 80AH	
Starting motor	12V - 2.3kW	
Alternator	12V - 55A	

HYDRAULIC SYSTEM

Main pumps		
Type	Variable displacement piston pumps	
Rated flow	2 x 38.5 + 23.5 + 11.2 L/min	
Sub-pump for pilot circuit	Gear pump	
Hydraulic motors		
Travel	Two speed axial piston motor with counter balance valve and parking brake	
Swing	Axial piston motor with automatic brake	
Relief valve setting		
Implement circuits	230 Kgf/cm ² (3,270 psi)	
Travel circuit	230 Kgf/cm ² (3,270 psi)	
Swing circuit	200 Kgf/cm ² (2,840 psi)	
Pilot circuit	30 Kgf/cm ² (430 psi)	
Service valve	Installed	

HYDRAULIC CYLINDER

No. of cylinder - bore x stroke		
Boom	85 x 540 mm (3.3" x 21.3")	
Arm	80 x 585 mm (3.1" x 23.0")	
Bucket	70 X 510 mm (2.8" x 20.1")	
Boom swing	80 X 400 mm (3.1" x 15.7")	
Dozer blade	95 X 152 mm (3.7" x 6.0")	

NOISE LEVEL(CAB)

Noise Levels (dynamic value)		
LwA	94dB	
LpA	75dB	

COOLANT & LUBRICANT CAPACITY

(refilling)	liter	US gal	UK gal
Fuel tank	42	11.1	9.2
Engine coolant	5	1.32	1.1
Engine oil	6.7	1.77	1.5
Hydraulic tank	46	12.2	10.1

TRAVEL LEVERS

Traveling and steering : Two levers with pedals.

CONTROL LEVERS

Type		
Pilot control	Two joysticks with one safety lever (LH): Swing and arm, (RH): Boom and bucket with horn (ISO)	
Engine throttle	Mechanical, cable type	

SWING SYSTEM

Swing motor	Axial piston motor
Swing reduction	Planetary gear reduction
Swing circuit lubrication	Grease - bathed
Swing brake	Wet disc
Swing speed	9.5 rpm

DRIVES & BRAKES

Max. travel speed(high) / (low)	4.5km / 2.5km (2.8mph) / (1.6mph)
Maximum traction force	3.1ton
Maximum gradeability	30°
Parking brake	Wet disc

DIGGING FORCE(ISO)

	1.3m Arm	1.6m Arm
Bucket	3,200 kgf	3,200 kgf
	31.4 kN	31.4 kN
	7,050 lbf	7,050 lbf
Arm	1,990 kgf	1720 kgf
	19.5 kN	16.9 kN
	4,390 lbf	3,790 lbf

WEIGHT(APPROXIMATE)

Operating weight, including 2,500 mm (8' 2") boom, 1,300 mm (4' 3") arm, SAE heaped 0.11 m³ (0.14 yd³) excavator bucket, lubricant, coolant, full fuel tank, hydraulic tank and the standard equipment.

Shoe Width	Rubber 300mm (12")	Steel 300mm (12")
Operating Weight	Cabin 3,650 kg (8,050lb)	3,750 kg (8,270lb)
Weight	Canopy 3,500 kg (7,720lb)	3,600 kg (7,940lb)
Ground Pressure	Cabin 0.33 kg/cm ² (4.76psi)	0.34 kg/cm ² (4.9psi)
	Canopy 0.32 kg/cm ² (4.57psi)	0.33 kg/cm ² (4.7psi)

UNDERCARRIAGE











X-leg type center frame is integrally welded with reinforced box-section track frames. The undercarriage includes lubricated rollers, track adjusters with shock absorbing springs and sprockets, and rubber shoes.

Center frame	X-leg type
Track frame	Pentagonal box type
No. of carrier roller on each side	1
No. of track roller on each side	4











LIFTING CAPACITIES R35Z-9

 Rating over-front  Rating over-side or 360 degree

Boom : 2.50 m (8' 2") / Arm : 1.30 m (4' 3") / Bucket : 0.11 m³ (0.14 yd³) SAE heaped / Dozer blade up : 300mm(12") rubber track

Load point height m(ft)		Load radius								At max. reach		
		1.0 m(3 ft)		2.0 m(7 ft)		3.0 m(10 ft)		4.0 m(13 ft)		Capacity		Reach
												m (ft)
4.0 m	kg									*540	500	3.94
13 ft	lb									*1190	1100	(12.9)
3.0 m	kg						550	470		420	350	4.74
10 ft	lb						1210	1040		930	770	(15.6)
2.0 m	kg					*790	750	540	460	360	300	5.11
7 ft	lb					*1740	1650	1190	1010	790	660	(16.8)
1.0 m	kg					820	690	520	430	340	280	5.18
3 ft	lb					1810	1520	1150	950	750	620	(17.0)
Ground	kg			1570	1250	780	650	500	420	360	300	4.98
Line	lb			3460	2760	1720	1430	1100	930	790	660	(16.3)
-1.0 m	kg	*2100	*2100	1580	1260	780	640	500	410	440	370	4.45
-3 ft	lb	*4630	*4630	3480	2780	1720	1410	1100	900	970	820	(14.6)
-2.0 m	kg			*1540	1300	800	670					
-7 ft	lb			*3400	2870	1760	1480					

Boom : 2.50 m (8' 2") / Arm : 1.30 m (4' 3") / Bucket : 0.11 m³ (0.14 yd³) SAE heaped / Dozer blade down : 300mm(12") rubber track

Load point height m(ft)		Load radius								At max. reach		
		1.0 m(3 ft)		2.0 m(7 ft)		3.0 m(10 ft)		4.0 m(13 ft)		Capacity		Reach
												m (ft)
4.0 m	kg									*540	530	3.94
13 ft	lb									*1190	1170	(12.9)
3.0 m	kg							*610	490	*550	380	4.74
10 ft	lb							*1340	1080	*1210	840	(15.6)
2.0 m	kg					*790	*790	*660	480	*570	320	5.11
7 ft	lb					*1740	*1740	*1460	1060	*1260	710	(16.8)
1.0 m	kg					*1120	730	*770	460	*590	300	5.18
3 ft	lb					*2470	1610	*1700	1010	*1300	660	(17.0)
Ground	kg			*1720	1340	*1310	690	*850	440	*610	320	4.98
Line	lb			*3790	2950	*2890	1520	*1870	970	*1340	710	(16.3)
-1.0 m	kg	*2100	*2100	*2240	1350	*1260	680	*790	440	*610	390	4.45
-3 ft	lb	*4630	*4630	*4940	2980	*2780	1500	*1740	970	*1340	860	(14.6)
-2.0 m	kg			*1540	1390	*870	710					
-7 ft	lb			*3400	3060	*1920	1570					

1. Lifting capacity is based on SAE J1097, ISO 10567.

2. Lifting capacity of the Robex Series does not exceed 75% of the tipping load with the machine on firm, level ground or 87% of full hydraulic capacity.

3. The load point is a hook located on the back of the bucket.

4. (*) indicates the load limited by hydraulic capacity.

Specifications

LIFTING CAPACITIES R35Z-9

Rating over-front Rating over-side or 360 degree

Boom : 2.50 m (8' 2") / Arm : 1.60 m (5' 3") / Bucket : 0.11 m (0.14 yd) SAE heaped / Dozer blade up : 300mm(12") rubber track

Load point height m(ft)		Load radius								At max. reach		
		1.0 m(3 ft)		2.0 m(7 ft)		3.0 m(10 ft)		4.0 m(13 ft)		Capacity		Reach m (ft)
4.0 m	kg									*490	420	4.35
13 ft	lb									*1080	930	(14.3)
3.0 m	kg							*520	480	370	310	5.06
10 ft	lb							*1150	1060	820	680	(16.6)
2.0 m	kg							550	460	320	270	5.40
7 ft	lb							1210	1010	710	600	(17.7)
1.0 m	kg			1630	1310	830	690	520	430	310	260	5.47
3 ft	lb			3590	2890	1830	1520	1150	950	680	570	(17.9)
Ground	kg			1550	1230	780	650	500	410	320	270	5.28
Line	lb			3420	2710	1720	1430	1100	900	710	600	(17.3)
-1.0 m	kg	*1740	*1740	1550	1240	770	630	490	400	380	320	4.80
-3 ft	lb	*3840	*3840	3420	2730	1700	1390	1080	880	840	710	(15.7)
-2.0 m	kg	*2470	*2470	1590	1270	780	650					
-7 ft	lb	*5450	*5450	3510	2800	1720	1430					

Boom : 2.50 m (8' 2") / Arm : 1.60 m (5' 3") / Bucket : 0.11 m (0.14 yd) SAE heaped / Dozer blade down : 300mm(12") rubber track

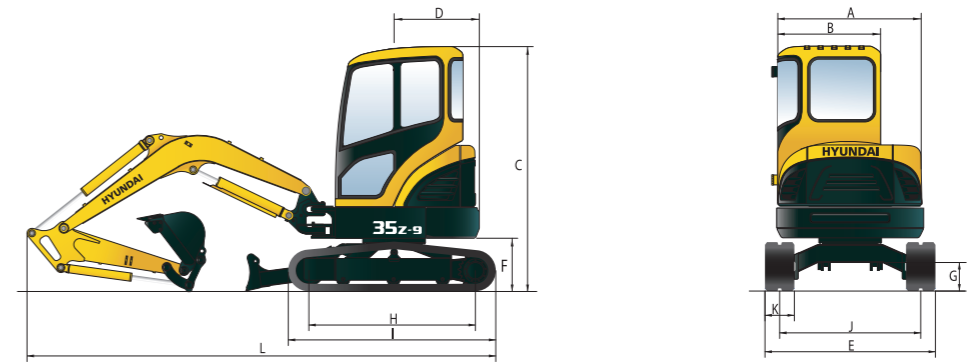
Load point height m(ft)		Load radius								At max. reach		
		1.0 m(3 ft)		2.0 m(7 ft)		3.0 m(10 ft)		4.0 m(13 ft)		Capacity		Reach m (ft)
4.0 m	kg									*490	450	4.35
13 ft	lb									*1080	990	(14.3)
3.0 m	kg							*520	500	*500	330	5.06
10 ft	lb							*1150	1100	*1100	730	(16.6)
2.0 m	kg							*590	490	*520	290	5.40
7 ft	lb							*1300	1080	*1150	640	(17.7)
1.0 m	kg			*1940	1410	*1010	740	*720	460	*540	270	5.47
3 ft	lb			*4280	3190	*2230	1630	*1590	1010	*1190	600	(17.9)
Ground	kg			*1710	1320	*1260	690	*820	440	*560	280	5.28
Line	lb			*3770	2910	*2780	1520	*1810	970	*1230	620	(17.3)
-1.0 m	kg	*1740	*1740	*2410	1320	*1290	670	*820	430	*570	340	4.80
-3 ft	lb	*3840	*3840	*5310	2910	*2840	1480	*1810	950	*1260	750	(15.7)
-2.0 m	kg	*2470	*2470	*1850	1350	*1040	690					
-7 ft	lb	*5450	*5450	*4080	2980	*2290	1520					

- Lifting capacity is based on SAE J1097, ISO 10567.
- Lifting capacity of the Robex Series does not exceed 75% of the tipping load with the machine on firm, level ground or 87% of full hydraulic capacity.

- The load point is a hook located on the back of the bucket.
- (*) indicates the load limited by hydraulic capacity.

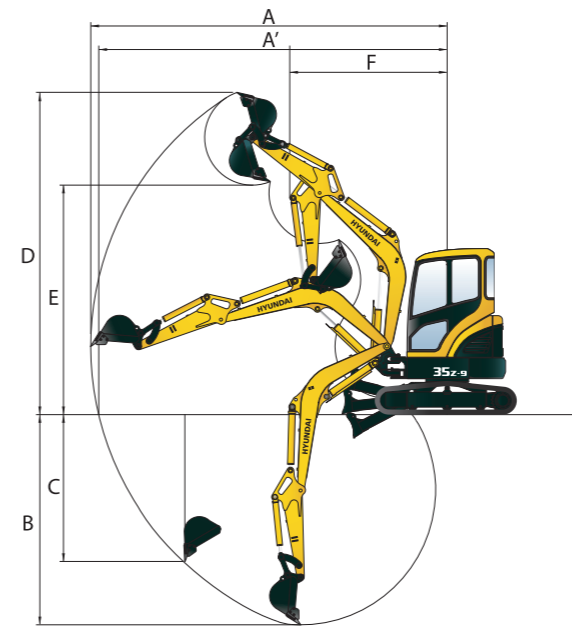
Dimensions & Working Range

R35Z-9 DIMENSIONS



A Overall width of upper structure	1,500 (4' 11")	G Ground clearance	290 (0' 11")
B Overall width of cab	1,050 (3' 5")	H Tumbler distance	1,700 (5' 7")
C Overall height of cab	2,500 (8' 2")	I Track length	2,130 (6' 12")
D Tail swing radius	870 (2' 10")	J Track gauge	1,440 (4' 9")
E Overall width	1,740 (5' 9")	K Track shoe width	300 (0' 12")
F Clearance under counterweight	540 (1' 9")	L Overall length	4,790 (15' 9")

R35Z-9 WORKING RANGE



Boom length	2,500 (8' 2")	
Arm length	1,300 (4' 3")	1,600 (5' 3")
A Max. digging reach	5,360 (17' 7")	5,610 (18' 5")
A' Max. digging reach at ground	5,240 (17' 2")	5,490 (18' 0")
B Max. digging depth	3,150 (10' 4")	3,440 (11' 3")
C Max. vertical wall digging depth	2,190 (7' 2")	2,450 (8' 0")
D Max. digging height	4,830 (15' 10")	5,000 (16' 5")
E Max. dumping height	3,450 (11' 4")	3,610 (11' 10")
F Min. swing radius	2,350 (7' 9")	2,370 (7' 9")